

RWA - Steuerung RWD 2a

Leitungslängen im Bus-System

Linien-Topologie

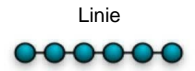
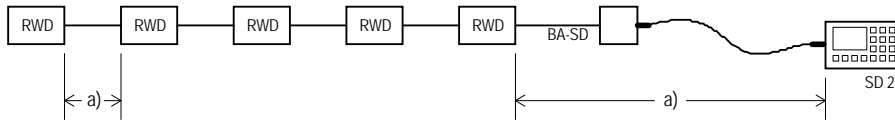

Bus-Topologie

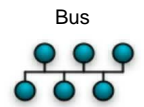
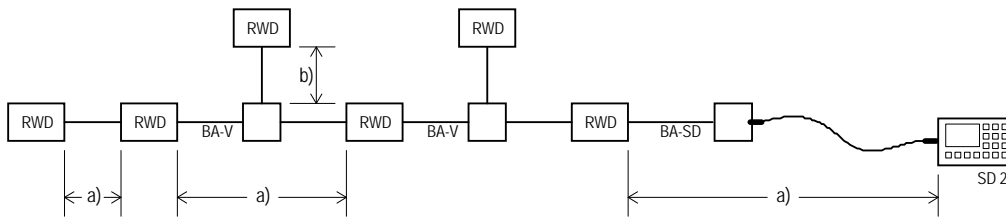

Ring- / Baum- / Gemischte Topologie

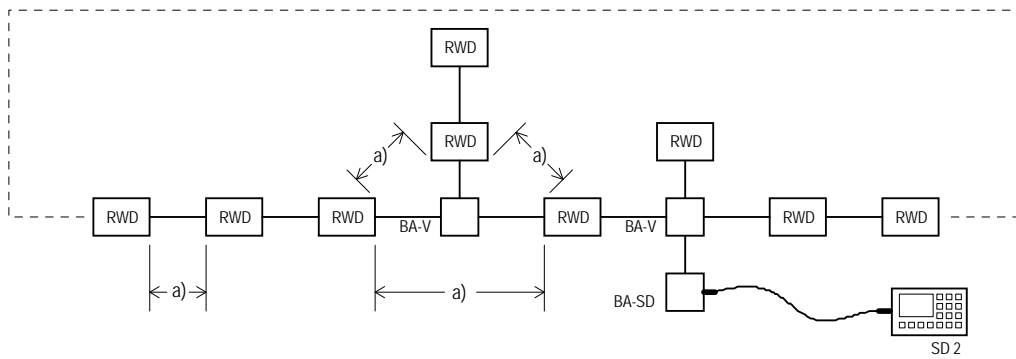

Ring / Baum / Gemischt

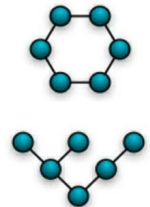

Maximal zulässige Leitungslängen

Topologie	Gesamtlänge der Bus-Leitungen im System	a) Leitungslänge von RWD zu RWD	b) Stichlänge
Linie	2500 m	500 m	-
Bus	2500 m	500 m	3 m
Ring / Baum / Gemischt	500 m	500 m	-

RWA - Steuerung RWD 2a

Anschließen der Bus-Leitung

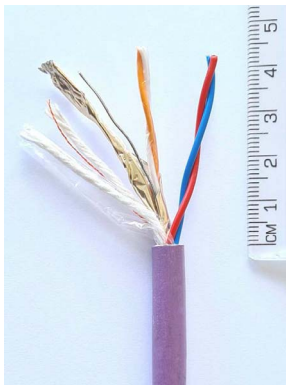

Bus-Leitung abmanteln

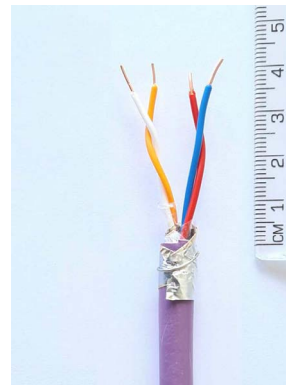

Abschirmung und Beidraht um die Leitung wickeln

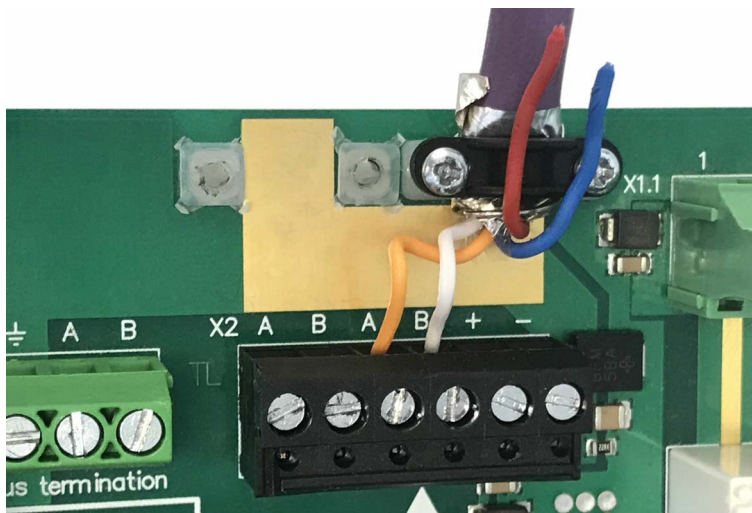

Bus-Leitung RWD <=> RWD

(A orange / B weiß)

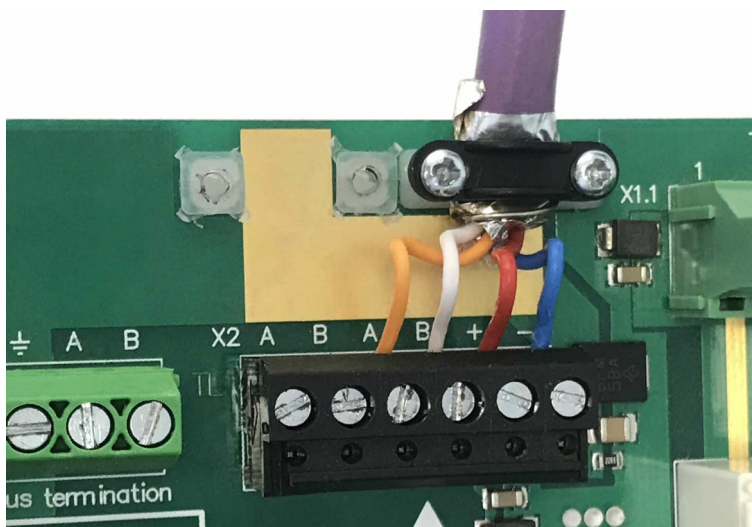

Bus-Leitung RWD <=> SD

(A orange / B weiß / + rot / - blau)